



# FASHION SPEAKER



## F-49S SPECIFICATIONS

General Specification	
Type	F-49S
Frequency Response	90-20KHz
Sensitivity	88dB
Rated power	20W
Rated Taps	20W/10W/5W/2.5W;8Ω
Line voltage	100V/70V
Dimension(L*W*H)(mm)	158*129*238
Physical Specification	
Material	HIPS
Grill	Powder Coated AL Mesh
Component(L.Speaker)	4" Woofer
Component(H.Speaker)	1" PEI
Finished Colour	White/Black
Unit Weight	2.5Kg
Woofer Speaker Specification	
Voice Coil Size	Φ25. 5*Φ0. 15*2Layer
DC Impedance	7.2Ω
Former	ASV
Magnet	Ferrite(305g)
	Φ80*Φ32*15(Y30)
Basket	Iron
Cone Material	PP
Spider	Cloth
Dust cap	PP
Net Weight	685g

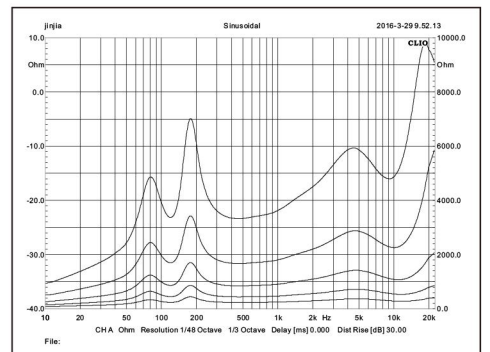
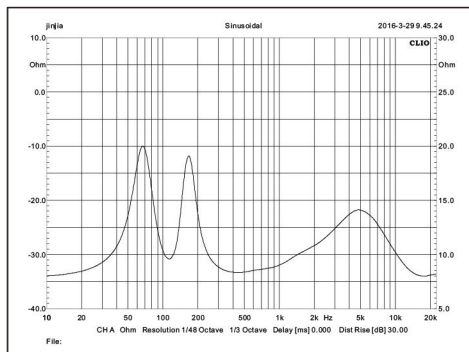
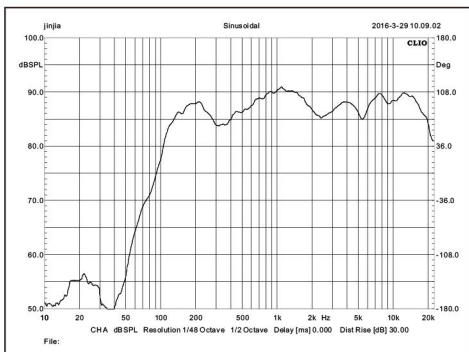
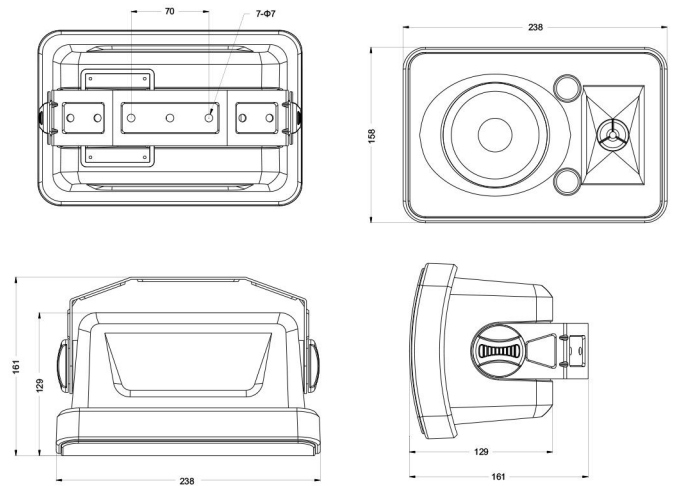

# Horizontal:

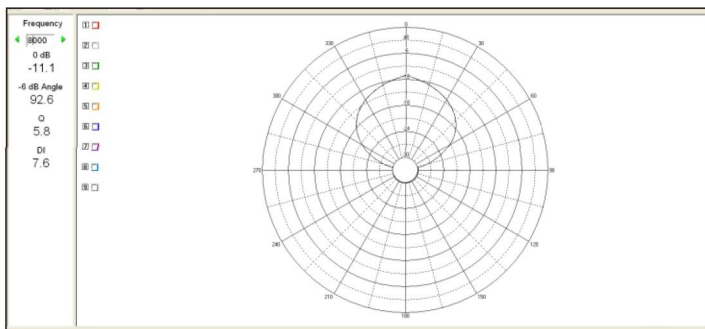
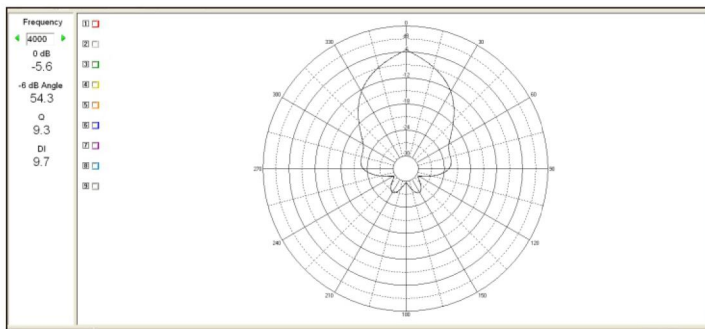
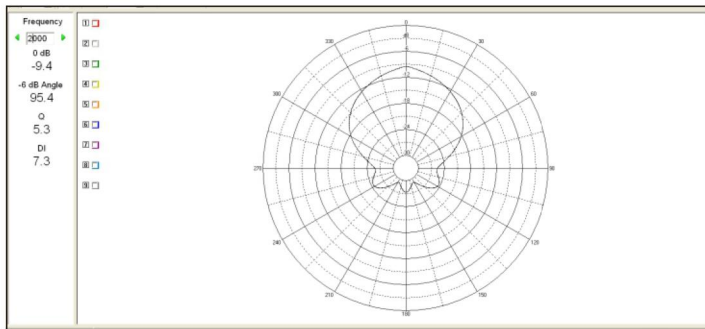
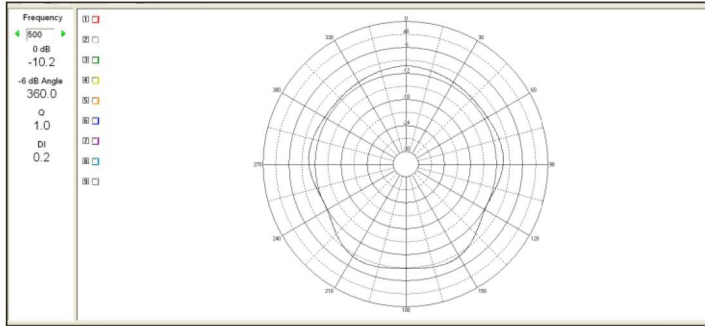
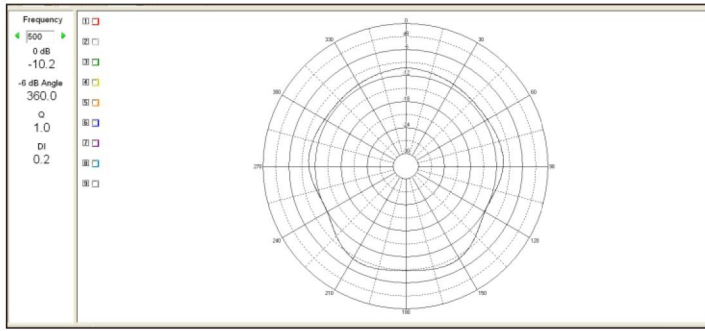

# Vertical:

