



# FASHION SPEAKER



## F-69S SPECIFICATIONS

General Specification	
Type	F-69S
Frequency Response	70-20KHz
Sensitivity	90dB
Rated power	60W
Rated Taps	60W/30W/15W/7.5W&8Ω
Line voltage	100V/70V
Dimension(L*W*H)(mm)	214*178*329
Physical Specification	
Material	HIPS
Grill	Powder Coated AL Mesh
Component(L.Speaker)	6.5" Woofer
Component(H.Speaker)	1" Silk
Finished Colour	White/Black
Unit Weight	4.5Kg
Woofer Speaker Specification	
Voice Coil Size	ASVΦ25.5*Φ0.19*2Layer
DC Impedance	6.8Ω
Former	ASV
Magnet	Ferrite(400g) Φ90*Φ32*15(Y30)
Basket	Iron
Cone Material	Paper
Spider	Conex
Net Weight	1.1kg

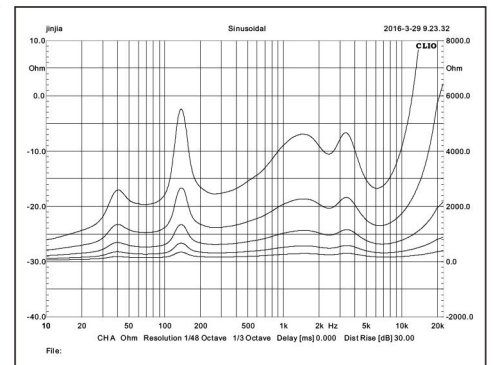
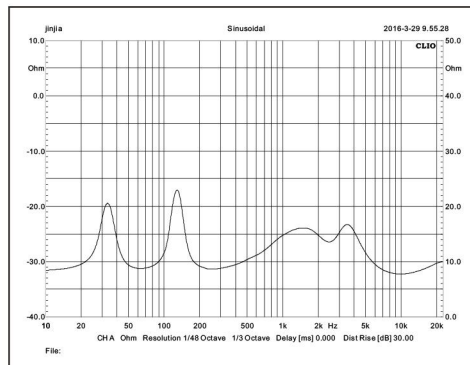
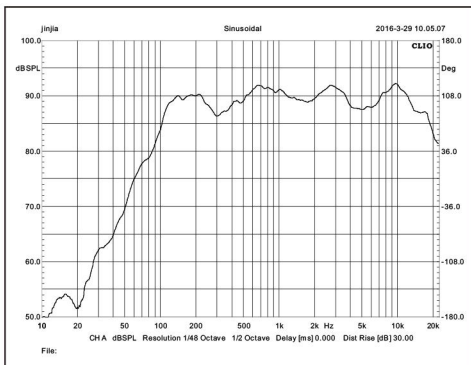
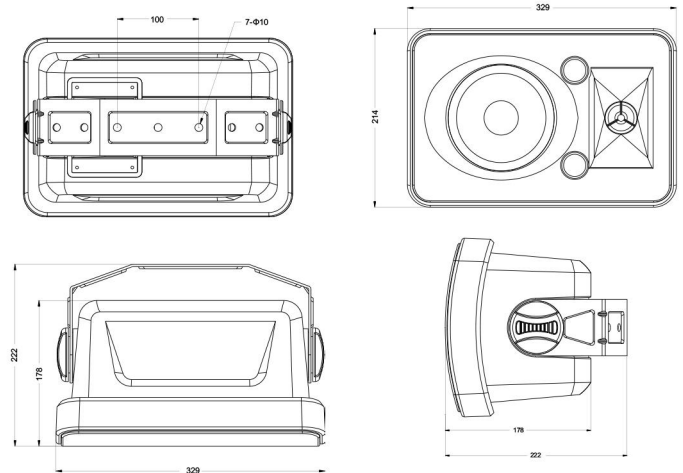

## Horizontal:

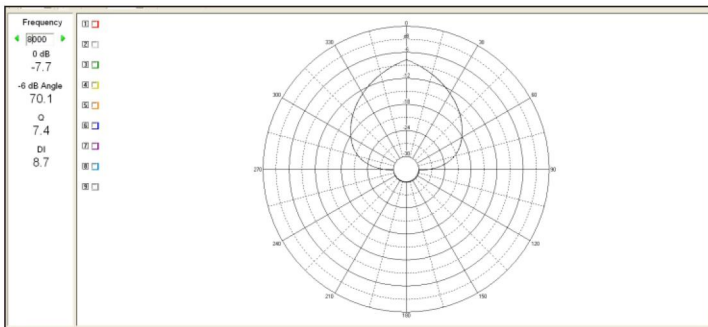
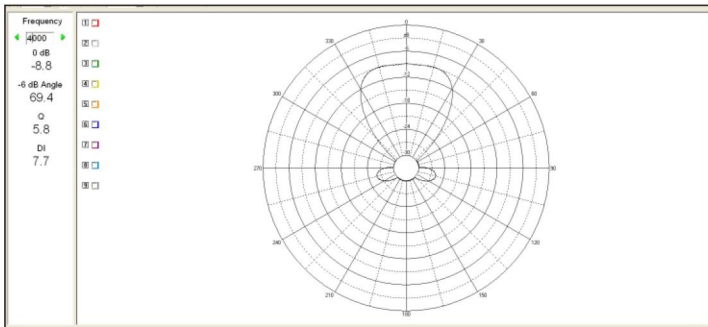
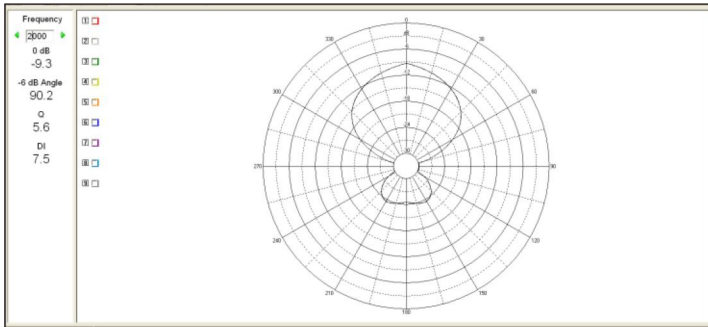
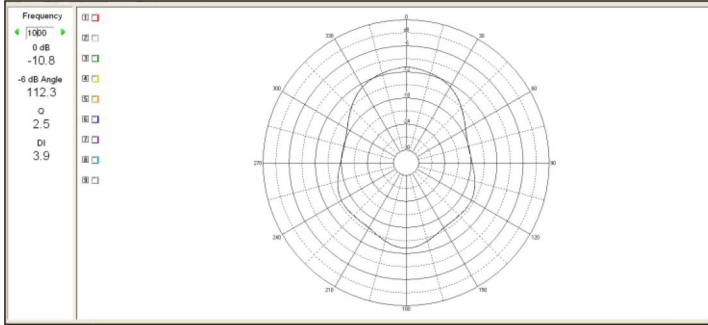
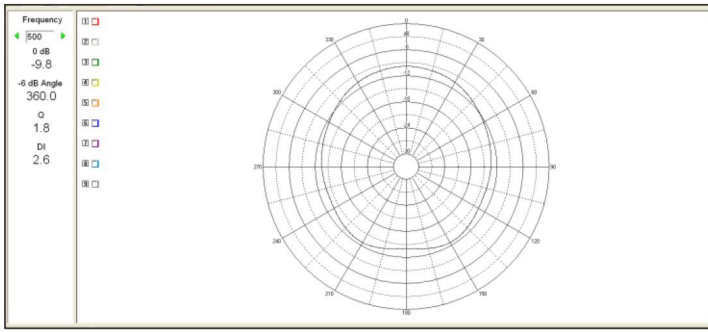

## Vertical:

